

NovaPro UHD

All-in-One Controller

V1.1.2

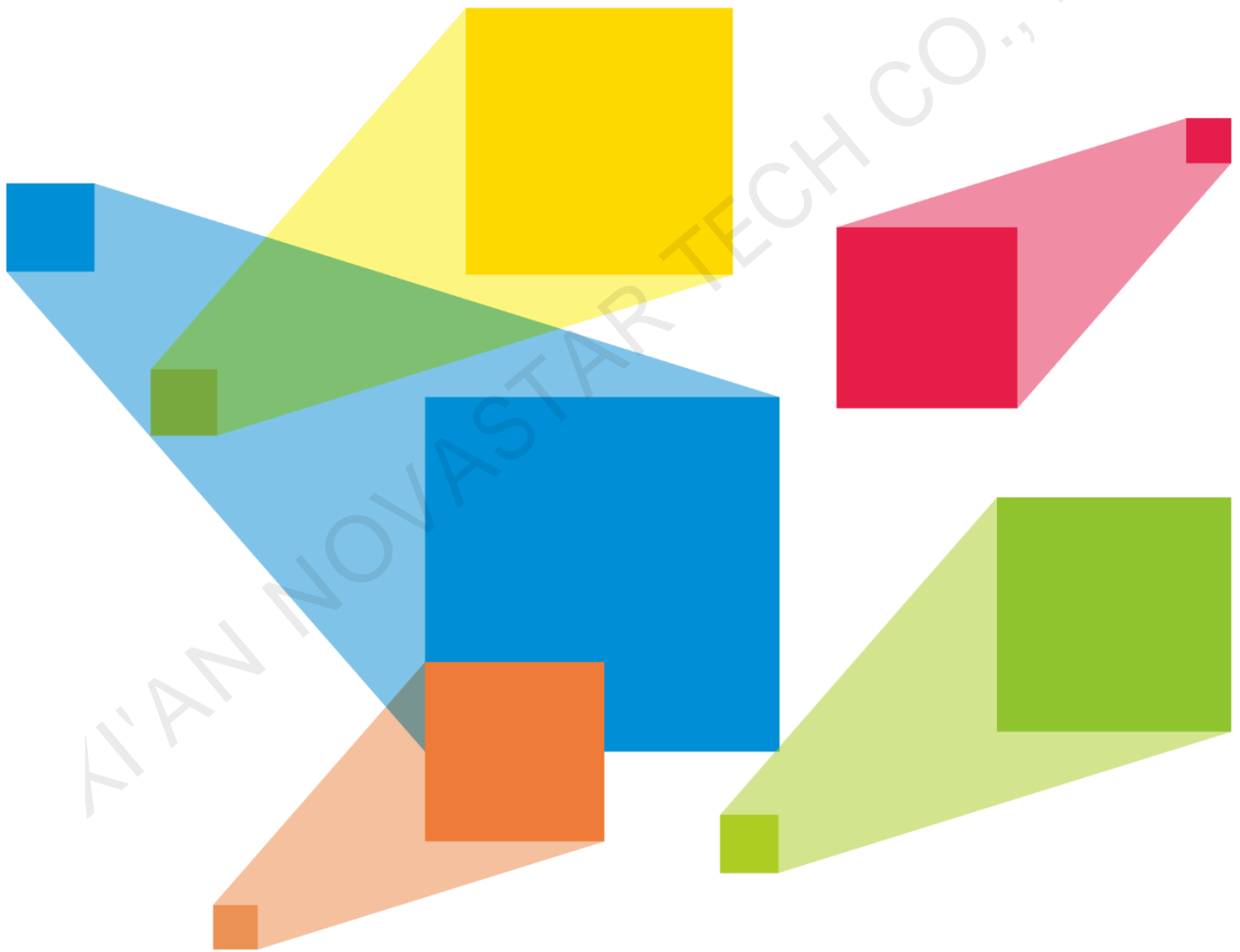

Specifications

Overview

The NovaPro UHD is a new all-in-one controller developed by NovaStar. Featuring video processing and control, and the built-in Master VI platform software, the NovaPro UHD allows you to easily manage layers and configure screens by using a mouse, keyboard and monitor.

The NovaPro UHD is capable of receiving a variety of video signals and processing images of resolutions up to Ultra HD 4Kx2K@60Hz and 8Kx1K@60Hz. It comes with a maximum loading capacity of 10,400,000 pixels and can send the processed videos to LED displays using Neutrik Ethernet ports and fiber optical ports.

Thanks to the powerful video processing and sending capabilities, the NovaPro UHD is widely used for high-end rental applications, stage control systems and fine-pitch fixed LED displays.

Features











- Industry-standard input connectors
 - 4x 12G-SDI (IN-LOOP)
 - 1x HDMI 2.0 (IN-LOOP)
 - 1x DP 1.2
 - 4x HDMI 1.3 (Purchase a DVI input card to replace the connectors.)
- 16x Neutrik Ethernet outputs and 4x OPT outputs
 - Two modes available on fiber optical output ports: copy and hot backup
 - The maximum loading capacity is 10,400,000 pixels. The maximum output width and height per unit reach up to 16,384 pixels 8192 pixels respectively.
- 6x layers
 - Up to 2x 4Kx2K and 4x 2Kx1K layers can be added, and layer scaling is available.
 - Flexible layer adjustment, including opacity, mask, overlapping, copying, mirroring, flipping, etc.
 - Irregular layer supported
 - Z-order sorting
- 1x OSD, 1x LOGO and 1x BKG
 - OSD supports cropping, opacity adjustment, dynamic and static images, and position settings.
 - LOGO supports resolutions up to 256x256 and allows for cropping, opacity adjustment and position settings.
 - BKG can be scaled to fit the screen automatically.
- Built-in Master VI platform software allowing for easier operations
- Working with the A8s or A10s Plus receiving card to support HDR function, making images smoother
- Low latency output
 - The end-to-end delay can be as low as 1 frame when the low latency and synchronization functions are turned on and the data runs vertically on the screen.
- Multiviewer settings
 - Monitor the input sources, PVW or PGM, or perform mixed monitoring.
- Web control
 - Access and control the NovaPro UHD in real time by using a browser without the need to install multiple pieces of software.
- Up to four NovaPro UHD units can be linked together for image mosaic.
- Decimal frame rates supported
 - The supported frame rates are 23.98 Hz, 29.97 Hz, 47.95 Hz, 59.94 Hz, 71.93 Hz and 119.88 Hz.

Appearance

Front Panel



Button	Function
On/OFF button	Hold down the button for 3 seconds to power on, power off or restart the device.
Layer buttons	<p>Open or close layers and display layer status.</p> <p>Status LEDs:</p> <ul style="list-style-type: none"> ● On (blue): The layer is open and an input source is accessed. ● Flashing (blue): The layer is being edited and an input source is accessed. ● On (white): The layer is open, but no input source is accessed. ● Flashing (white): The layer is being edited, but no input source is accessed or the input source is abnormal. ● Off: The layer is closed.
Input source buttons	<p>Quickly switch the layer input source and display the input source status.</p> <p>Press an input source button to switch to the input source.</p> <p>Status LEDs:</p> <ul style="list-style-type: none"> ● On (blue): The input source is accessed and being used by a layer. ● On (white): The input source is accessed but not in use. ● Off: <ul style="list-style-type: none"> - The input source is not accessed or abnormal. - The input source is not accessed but already used by a layer.
TFT screen	Display current device status, menus, submenus and messages.

Knob	<ul style="list-style-type: none"> • Rotate the knob to scroll through the menu items, or adjust a parameter value. • Press the knob to confirm the selection or settings.
Function buttons	<ul style="list-style-type: none"> • : Enter or exit the quick navigation screen. • : Make the LED screen fade to black. • : Access the LOGO menu. • : Access the preset menu. • : Freeze the output image. • : Access the OSD menu. • : Custom function button • : Access the test pattern menu. • : Access the BKG settings menu. • : Send the PVW to PGM with a transition effect. • : Send the PVW directly to PGM without a transition effect.
ESC button	Exit the current menu or cancel an operation.
USB ports	<p>2x USB2.0</p> <ul style="list-style-type: none"> • Connect to a mouse and keyboard to control the device with the built-in GUI. • Insert a USB drive to update the system. • Insert a USB drive to import or export files.

Note:

Hold down the knob and the ESC button simultaneously for 3 seconds or longer to lock or unlock the front panel buttons.

Rear Panel



Note:

The NovaPro UHD supports the replacement of the HDMI input card (standard configuration). You can buy a DVI input card to replace the HDMI input card.

Input		
Connector	Quantity	Description
12G-SDI	4	<ul style="list-style-type: none"> Supports ST-2082-1 (12G), ST-2081-1 (6G), ST-424 (3G) and ST-292 (HD). Up to 4Kx2K@60Hz input resolution Connector 4 supports deinterlacing processing. Supports 12G-SDI output with loop-through. <p>Note:</p> <p>When the input source is a 12G-SDI signal, a CANARE / L-4.5CHD+ / UHDTV-SDI SDI cable is required and it cannot be longer than 50 m.</p>
DP 1.2	1	<ul style="list-style-type: none"> Up to 4Kx2K@60Hz (8Kx1K@60Hz) input resolution HDCP 1.3 compliant Does not support interlaced input signals.
HDMI 2.0	1	<ul style="list-style-type: none"> Up to 4Kx2K@60Hz (8Kx1K@60Hz) input resolution HDCP 1.4 and HDCP 2.2 compliant Does not support interlaced input signals. Supports HDMI 2.0 output with loop-through.
HDMI 1.3	4	<ul style="list-style-type: none"> D_4xHDMI 1.3 input card (can be replaced by a D_4xDVI input card) Up to 1920x1080@60Hz input resolution for each connector HDCP 1.3 compliant Supports interlaced input signals.
Output		
Connector	Quantity	Description
Ethernet port	16	Neutrik Gigabit Ethernet outputs <ul style="list-style-type: none"> Max. loading capacity: 10.4 million pixels Max. width: 16,384 pixels Max. height: 8,192 pixels
OPT 1-4	4	10G fiber optical outputs (copy and hot backup)

		<ul style="list-style-type: none"> • OPT 1 transmits data on Ethernet ports 1–8. • OPT 2 transmits data on Ethernet ports 9–16. • OPT 3 is the copy/hot backup channel for OPT 1. • OPT 4 is the copy/hot backup channel for OPT 2.
MVR	1	HDMI 1.3 connector, used for Multiviewer to monitor input sources, PVM or PGM, or perform mixed monitoring
AUX	1	HDMI 1.3 connector, used for connecting to an auxiliary device such as a teleprompter
Control		
Connector	Quantity	Description
ETHERNET	1	For PC communication or network connection
USB	3	<ul style="list-style-type: none"> • 1x USB 2.0 (Type-B): Connect to the PC for device debugging. • 2x USB 2.0 (Type-A): <ul style="list-style-type: none"> - Insert a USB drive to update the system. - Connect to a mouse and keyboard. - Output port for linking another device unit
GENLOCK IN-LOOP	1	Connect to a synchronization signal source. <ul style="list-style-type: none"> • IN: Accept the sync source. • LOOP: Loop the sync source.
CONTROL UI	1	Connect to a monitor for displaying the user interface of the Master VI platform software.

Applications

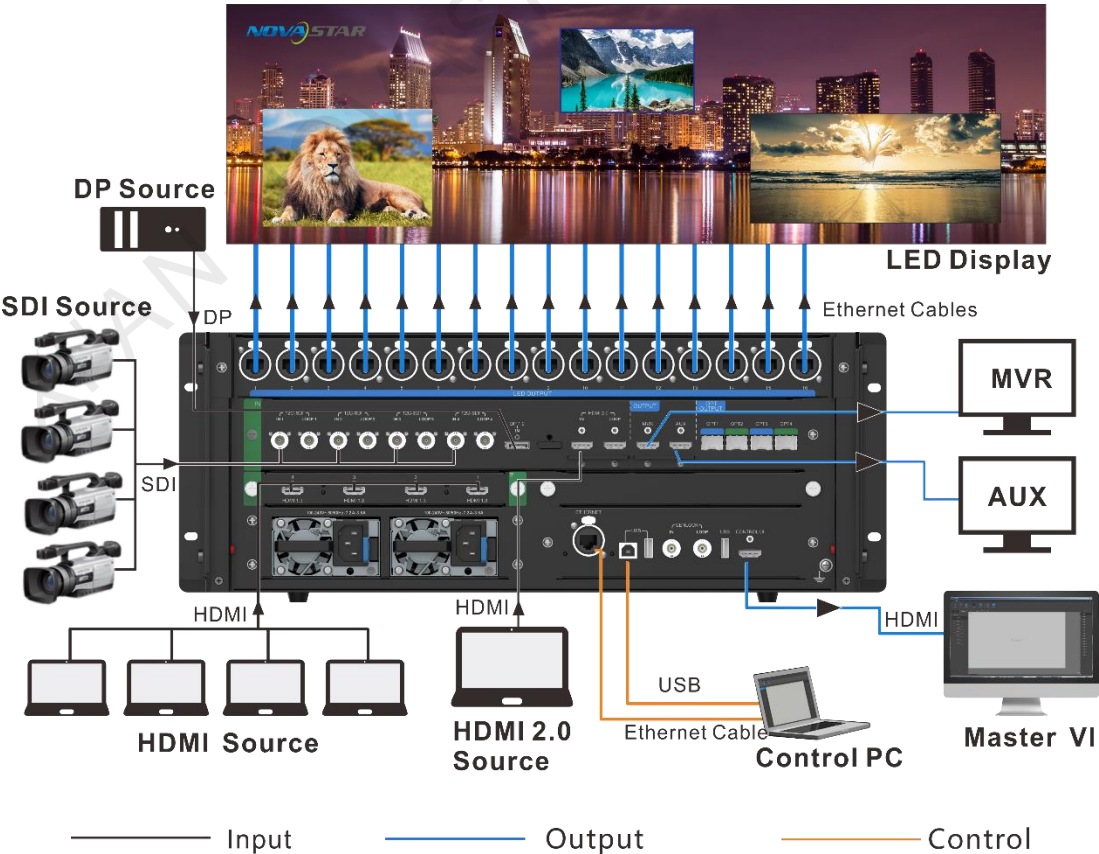

Dimensions

NovaPro UHD

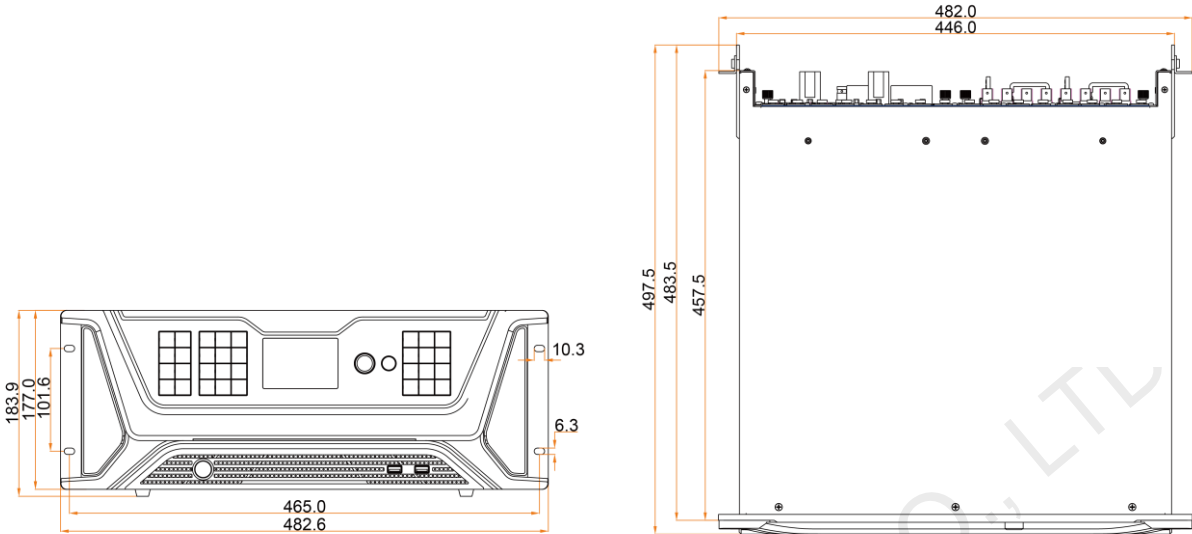

Tolerance: ±0.5 Unit: mm

Flight Case

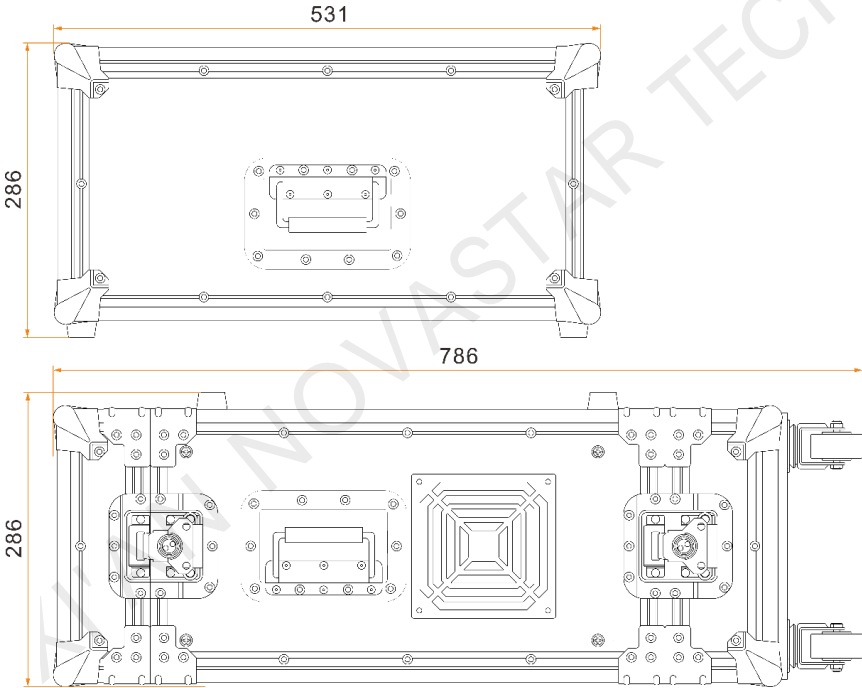

Tolerance: ±0.5 Unit: mm

Note:

If you need the detailed dimension drawings of the flight case, please contact the customer service of NovaStar.

Specifications

Overall Specifications		
Electrical Specifications	Power connectors	100–240V~, 50/60Hz, 7.2A–3.5A Dual redundant power supplies
	Rated power consumption	180 W
Operating Environment	Operating temperature	–10°C to +60°C
	Operating humidity	0% to 80%, non-condensing
Storage Environment	Storage humidity	0% to 95%, non-condensing
Physical Specifications	Dimensions	482.6 mm × 183.9 mm × 497.5 mm
	Net weight	21 kg
	Gross weight	42 kg
Packing Information	Accessories	<ul style="list-style-type: none"> • 2x Power cords • 1x DVI cable • 1x USB cable • 1x Ethernet cable • 1x HDMI cable • 1x DP cable • 1x Mini DP to DP cable • 46x Silicone dustproof plugs • 1x USB drive (16 GB) • 1x Custom Letter • 1x Quick Start Guide • 1x Certificate of Approval • 1x Safety Manual
	Flight case	531 mm × 286 mm × 786 mm
Certifications		FCC, IC, UL/CUL, CB, CE, RoHS 10, EAC, KC, RCM, PSE
Noise Level (typical at 25°C/77°F)		57 dB (A)

Video Source Features

Input Connector	Bit Depth		Max. Input Resolution
<ul style="list-style-type: none"> HDMI 2.0 DP 1.2 	8-bit	RGB 4:4:4	4096x2160@60Hz
		YCbCr 4:4:4	8192x1080@60Hz
		YCbCr 4:2:2	
		YCbCr 4:2:0	Not supported
	10-bit	RGB 4:4:4	4096x2160@30Hz
		YCbCr 4:4:4	8192x1080@30Hz
		YCbCr 4:2:2	4096x2160@60Hz 8192x1080@60Hz
		YCbCr 4:2:0	Not supported
	12-bit	RGB 4:4:4	4096x2160@30Hz
		YCbCr 4:4:4	8192x1080@30Hz
		YCbCr 4:2:2	4096x2160@60Hz 8192x1080@60Hz
		YCbCr 4:2:0	Not supported
HDMI 1.3	8-bit	RGB 4:4:4	1920x1080@60Hz
		YCbCr 4:4:4	
		YCbCr 4:2:2	
	10-bit	RGB 4:4:4	
		YCbCr 4:4:4	
		YCbCr 4:2:2	
	12-bit	RGB 4:4:4	
		YCbCr 4:4:4	
		YCbCr 4:2:2	
12G-SDI	<ul style="list-style-type: none"> Max. input resolution: 4096x2160@60Hz Does not support input resolution and bit depth settings. Supports ST-2082-1 (12G), ST-2081-1 (6G), ST-424 (3G) and ST-292 (HD). 		

Input and Output Resolutions

Input Resolutions						
Standard Resolution	Standard Frame Rate (Hz)	SL-DVI	DL-DVI	HDMI 1.3	HDMI 2.0	DP 1.2
1024x768	48/50/59.94/60/75/85	√	√	√	√	√
1280x720	23.98/24/25/29.97/30/48/50/59.94/60	√	√	√	√	√
1280x1024	48/50/59.94/60/75/85	√	√	√	√	√
1366x768	50/59.94/60	√	√	√	×	×
1440x900	60/75/85	√	√	√	√	√
1600x1200	48/50/59.94/60	√	√	√	√	√
1680x1050	60	√	√	√	√	√
1920x1080	23.98/24/25/29.97/30/48/50/59.94/60	√	√	√	√	√
1920x1200	50/59.94/60	√	√	√	√	√
2048x1080	30/48/50/59.94/60	√	√	√	√	√
2048x1152	30/60	√	√	√	√	√
2560x1080	50/59.94/60	×	√	×	√	√
2560x1600	50/59.94/60	×	√	×	√	√
2560x1600	120	×	×	×	√	√
3840x1080	30/50/59.94/60	×	√	×	√	√
3840x1080	120	×	×	×	√	√
3840x2160	30	×	√	×	√	√
3840x2160	60	×	×	×	√	√
1024x768	48/50/59.94/60/75/85	√	√	√	√	√
Output Frame Rates						
23.98Hz, 24Hz, 25Hz, 29.97Hz, 30Hz, 47.95Hz, 48Hz, 50Hz, 59.94Hz, 60Hz, 71.93Hz, 72Hz, 75Hz, 85Hz, 100Hz, 119.88Hz, 120Hz						

- √: The connector supports the resolution and frame rate.
- ×: The connector does not support the resolution and frame rate.
- Any input frame rate can be output at different frame rates.

FCC Caution

Any changes or modifications not expressly approved by the party responsible for compliance could void the user's authority to operate the equipment.

This device complies with part 15 of the FCC Rules. Operation is subject to the following two conditions: (1) This device may not cause harmful interference, and (2) this device must accept any interference received, including interference that may cause undesired operation.

Note: This equipment has been tested and found to comply with the limits for a Class A digital device, pursuant to part 15 of the FCC Rules. These limits are designed to provide reasonable protection against harmful interference when the equipment is operated in a commercial environment. This equipment generates, uses, and can radiate radio frequency energy and, if not installed and used in accordance with the instruction manual, may cause harmful interference to radio communications. Operation of this equipment in a residential area is likely to cause harmful interference in which case the user will be required to correct the interference at his own expense.

XI'AN NOVASTAR TECH CO., LTD.

Copyright © 2021 Xi'an NovaStar Tech Co., Ltd. All Rights Reserved.

No part of this document may be copied, reproduced, extracted or transmitted in any form or by any means without the prior written consent of Xi'an NovaStar Tech Co., Ltd.

Trademark

NOVA STAR is a trademark of Xi'an NovaStar Tech Co., Ltd.

Statement

Thank you for choosing NovaStar's product. This document is intended to help you understand and use the product. For accuracy and reliability, NovaStar may make improvements and/or changes to this document at any time and without notice. If you experience any problems in use or have any suggestions, please contact us via the contact information given in this document. We will do our best to solve any issues, as well as evaluate and implement any suggestions.

[Official website](http://www.novastar.tech)
www.novastar.tech

[Technical support](mailto:support@novastar.tech)
support@novastar.tech